

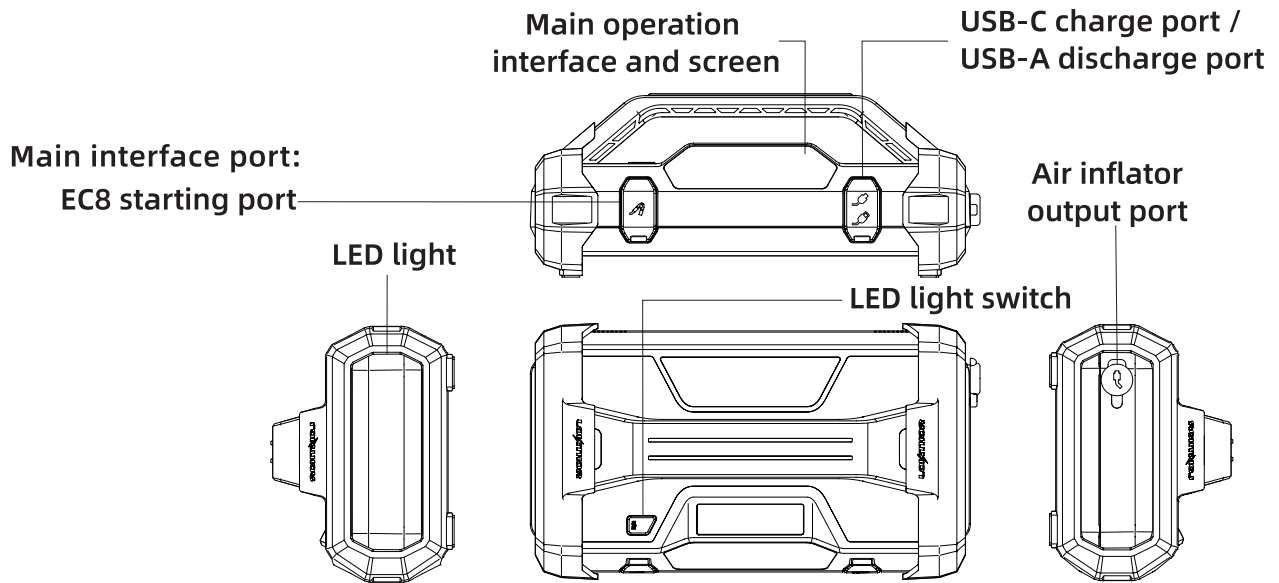







Product Overview

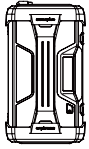

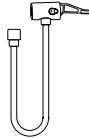
Parameter Specification

Product Model: JA302	Battery Capacity: 76Wh
Starting Voltage: 12V	Starting Current: 1200A
Peak Current: 2500A	Pressure Range: 10~150 PSI
Sensor Accuracy: ± 2 PSI	Input: USB-C 5V/3A , 9V/2A
Output: USB-A 5V/3A, 9V/2A	Polarity: Red(+), Black(-)
Operating Temp: -20 °C to 50 °C	Charging Temp: 0 °C to 45 °C
Storage Temp: -20 °C to 50 °C	Service life: >1000 cycles (in good condition)
Charging Time: 4.5~8 Hours	

Packing List

Multi-function vehicle emergency starter	Jump starter clamps	Inflatable hose	Nozzle adapters
			1.Presta Valve Adaptor 2.Inflatable Nozzles 3.Ball Needle 
Product storage bag	Accessories storage bag	Manual	USB-C cable
			

Product Introduction

1. Emergency start of 12V engine (up to 8.5-Liter gasoline and 6.5-Liter diesel 12 V engines)
2. Built-in air inflator, support tire pressure detection, preset charging and stopping value, unit switching and other functions; Air pressure sensor accuracy: ± 2 PSI, maximum inflation pressure 150 PSI;
3. LED lighting (luminous flux: 300 LUMENS, 3modes: SOS/stroboscopic/constant light)
4. Charging: USB-C (QC3.0, 5V/3A, 9V/2A) ;
5. Discharging: USB-A (QC3.0, 5V/3A, 9V/2A) .

